

The  
DARK  
AGES

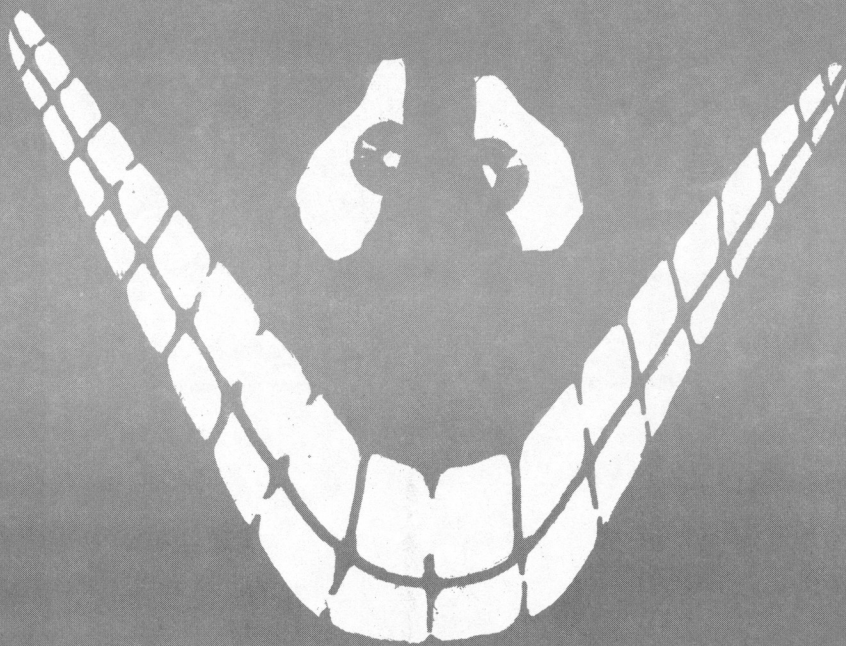

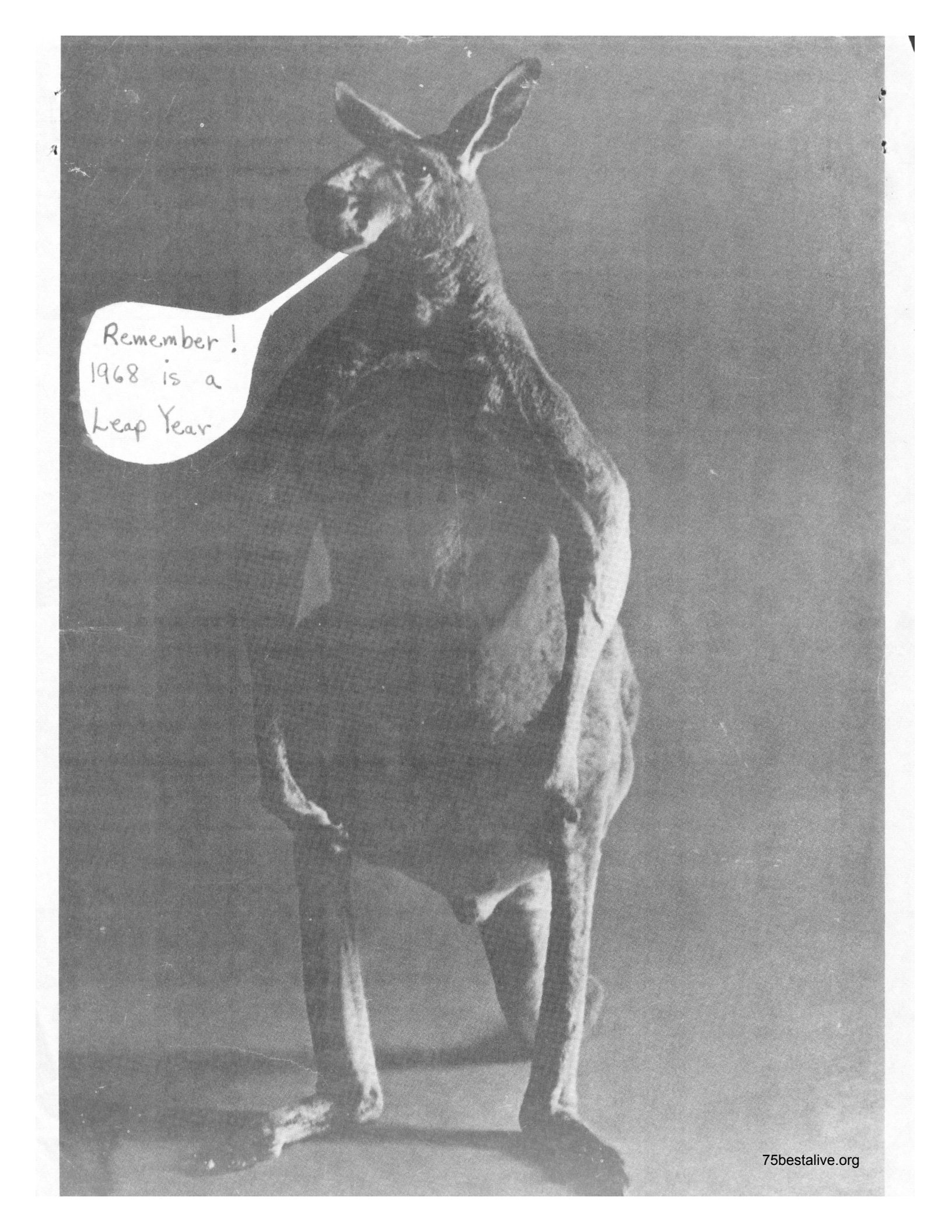

Remember!  
1968 is a  
Leap Year

AFCRP 190-4 1968 #1 JAN 68, NR1

# THE Dodo Staff

#1 GERM: Bill Radasky '68

- OTHER INFECTIONS:
- ROS DEAN '68
  - MIKE STEVENSON '68
  - JOHN LAMBERT '68
  - DAVE DANIEL '69
  - RICK GRANDJEAN '69
  - KOY BASS '70
  - CHARLIE BOBBISH '70
  - JIM WATERS '70
  - LARRY HAMMOND '71

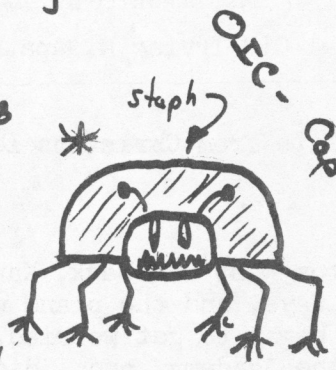

and a preview of the Dodo is gone!  
 Thrilling photos of the great streaks made this year  
 Basketball pep rallies w/instant replay  
 Action Coverage of 100th night  
 Coming Soon!

## EDITORIAL

For all of you who haven't asked yet, don't! Yes, I'm back along with the greatest bunch of meatheads this side of Chicago. We intend to put together issues of the Dodo which will get us all through the Dark Ages.

Many of you are probably wondering from whence the term "the dark ages" originated. Frankly so are we! But all you must do is look around you and you will see that the dark ages are here. Examples which are mentioned in this issue are overhead inspections, new "simplified" Security Flight details, new whitewall haircuts, spacious classrooms increasing the desire to learn, convenient parking of cadet cars at the North Gate, removal of cleats from cadet Gestapo shoes, and of course @rradiation of first calss figmosity.

In closing, for those of you who follow the stock market, the Brown-Jones Indifference Average for that hot selling stock, Figmosity T&T opened January 3rd at 2%. After a brisk trading of 3200 shares, the price is up to 68%. It is advised by the Dodo Staff that this stock will reach a new high by June, so ...

Buy now!

# Rad

PS Those of you who are wondering about the lack of a THE Man in our last couple issues and those of you who couldn't really care are to be informed that the Dodo Staff has lost a really good contributor in THE Helminski. A mind like his comes along only once in every thousand years...Thank goodness!



<b>REFERRAL OF OFFENSES AND AWARD OF PUNISHMENTS</b>	TYPE (Check one)	DATE
	<input checked="" type="checkbox"/> EXPLANATION <input type="checkbox"/> RECONSIDERATION	9 Jan 68
TO Air Officer Commanding	SQUADRON	GROUP
THRU <u>21st</u> Cadet Squadron Commander	21	4

DATE OFFENSE REPORTED ON AFCW FORM 10	OFFENSE REPORTED BY (Name and Grade)
8 Jan 68	C1C Irving M. Apathy

REMARKS (Continue on separate sheet if additional space is required)

1. The offense "Signing in five days late from Christmas Leave, 8 Jan 68" is correct.

2. I was scheduled for a return hop from West Hogsback, Kansas, leaving on 2 Jan. It had been snowing for eleven days, and the plane was grounded. I waited around for twelve hours, then I began to get worried. I had only been written up twice since I have been at the Academy, and I did not want to tarnish my military career. I tried to get a commercial flight, but as you may know, there are not many commercial flights out of West Hogsback. I finally got a ride on a tractor with an Army enlisted man, Pvt. Parks, on the third. We drove all night long, being very careful not to get a ticket, but we hit a dim figure in a blue suit who simply shouted at us, "Press on, ACE!" Arriving at Richards-Gebaur late that night, I was able to ride in a cargo plane full of putrid meat to Colorado Springs. I still can't understand why that food plane was stopping at Peterson Field. Since there were no buses or taxis there, I tried to get a ride with a returning officer. After being released from the Penrose Hospital the next day, I realized that I had lost my watch and I went to the liquor store. ~~In a drunken stupor~~ After reinforcing my strength, I crawled to the Mainland Rent-a-Car. However, they would not rent to me because I was under 26 and did not carry \$300 deductible. Right after I woke up in the ditch with a terrible headache, I thumbed a ride to the Cadet area. There was a note on my desk saying that if I did not send more money to my wife, she would never let me see the kids again. I left to go to Denver. Just this side of Castle Rock, I was attacked by a man-eating Vette, which I quickly waylaid with UC. Longing for the gray tomb I returned. I was just finishing off some Thunderbird W/pot when the CCQ came in and reminded me to sign in.

3. The offense was not intentional.

TYPED NAME, GRADE AND CADET SERVICE NUMBER	SIGNATURE
Melvin T. Fahrquar C2C 69CCOT2A1K	<i>Melvin T. Fahrquar</i>

*No offense - remove report  
 This man tried his best to get back on time, and we must show him that effort is rewarded. He did just what I would have done.*

AOC _____ Sq	DATE
--------------	------

NO OFFENSE - REMOVE REPORT

ARY BOARD ACTION IAW AFRCR 35-6.

TO	COC (CDPA)
<input type="checkbox"/> APPROVED	<input type="checkbox"/> FOR CDB ACTION
<input type="checkbox"/> DISAPPROVED	
GROUP AOC SIGNATURE	

# THE ~~Old~~ ~~is~~ ~~MAKES~~ ~~WAY~~ for the ~~NEW~~

Last month, at a top-priority meeting convened to explain vital areas of Wing Expansion, a new Security Flight was unveiled. This exciting innovation was conceived in the hallowed names of Flexibility and Cost Effectiveness. The charts below indicate to the layman the subtle differences between the Old and the New:

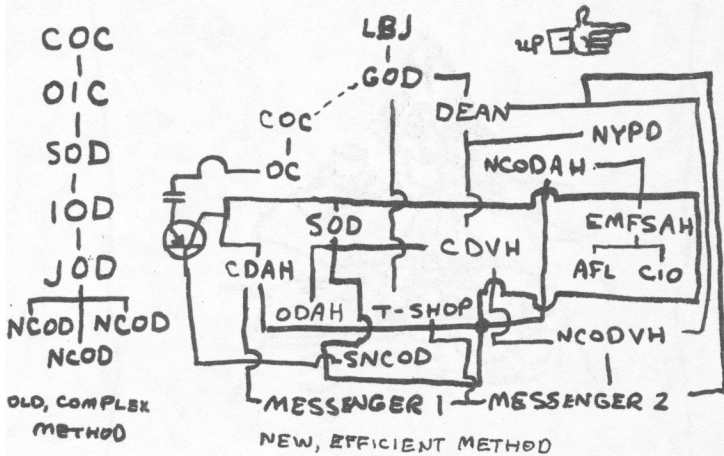

Another mistaken idea is that Security Flight Cadet officers' carrying sabers is a borrowed custom from Hudson High or Canoe U. Actually, the idea was ours first and they stole it from us. (This also explains why we have so many unique traditions.)

If, some afternoon around 1730 (5:30 to you), you happen to be wandering around the terrazzo instead of polishing shoes, and you spy a humongous number of people milling about aimlessly (this doesn't necessarily distinguish them from the rest of the Wing), you will know that the group is the oncoming Detail with CCQ's. That was a long sentence, wasn't it? The elaborate ceremony described below, with all its pagan simplicity, is known as The Change of Command. It is military and it builds character.

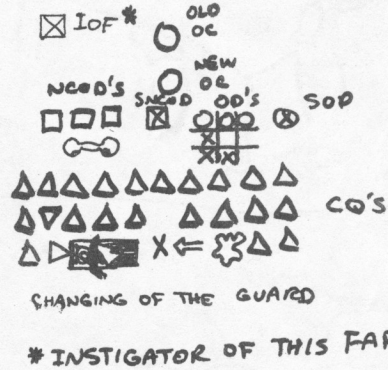

The hard-hitting, brilliant masterpiece is based on the concept that Security Flight ought to be more unified in efforts and appearance. For this reason, all Detail members wear red armbands. Reliable sources have discounted rumors that we got a real good deal from the manufacturer. On 2 Jan 68, Plan Green went into action. (Green due to Mad's envy of such a brilliant spoof of the military system.)

No longer does one need to memorize hard-to-say phrases such as JOD or IOD when answering the phone. Now a simple NCODVH will suffice. There are OD's and NCOD's for both dorms and Arnold Hall, plus two fourth class messengers who do all the work. The New Dorm has recently acquired a Security Flight phone; this, plus an intercom hookup, allows them to talk with the working members of the Detail in the old dorm. Duties of the New Dorm personnel consist of turning on the uniform light switches. Incidentally, the New Dorm was not, as some believe, named for Capt. T.E. New, but the name does serve a purpose until the authorities can decide between naming it for LBJ or for Esther in the C-Store.

You may complain that there is nothing that is fun to do on Security Flight. Such a comment is completely unjustified. The Public Address console can provide a world of entertainment. For those of you who cannot walk and chew gum at the same time, the revised console, though extremely simple for even the most moronic idiot, can and has been used improperly. For example, you can chew out Doolies over the intercom, talk to Fairchild Hall, or play the radio all over the world at night, during study time and after taps. Lastly, soon the OC and SOD will begin wearing a badge similar to the AP's. If this keeps up, the uniform may look like

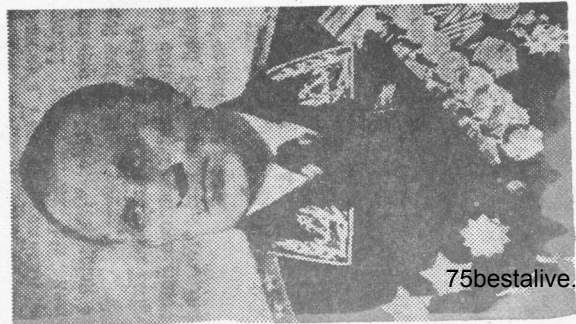

HEARD

AROUND

CAMPUS . . . .

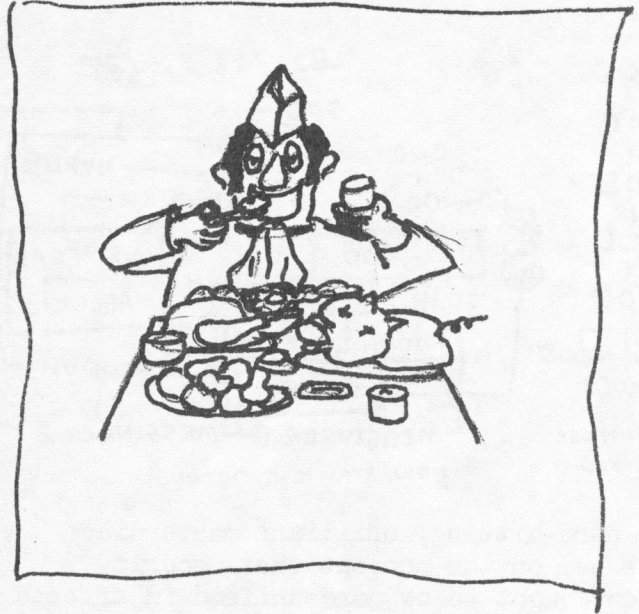
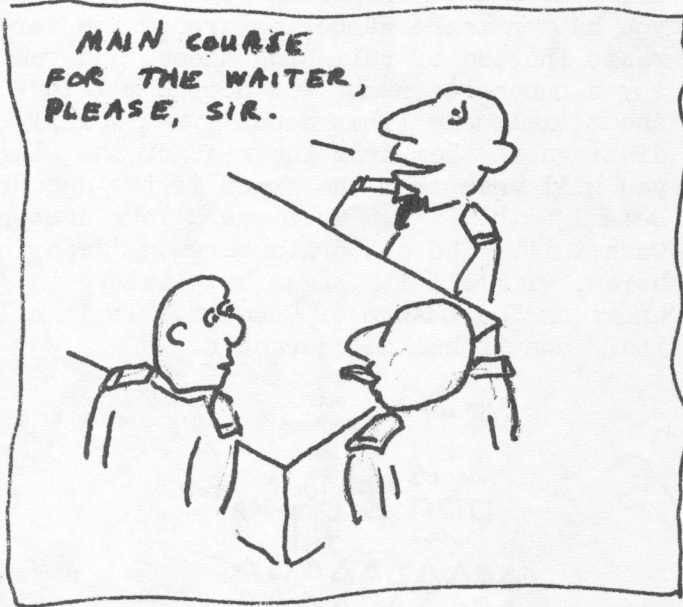

"A guy gets a couple of 'Fs' and wham."

DOTS & DOOLES

Q: Why did the chicken go half way across the street?  
 A: He wanted to lay it on the line!

A SONG

When I was seventeen  
 it was a very poor year.  
 It was a very poor year  
 for hot blooded dools  
 Who lost all their curls  
 and who dreamt of their girls  
 and fought with the Dean  
 When I was seventeen.

Now that I'm twenty one  
 it is a figmo year.  
 It is a figmo year  
 for dirty old men  
 Who dream of their wings  
 and think of the things  
 that in June will soon come.  
 Now that I'm twenty one.



Two comedians were in New York City.  
 The first one asks: Did you come here by way of Buffalo?  
 The second says: No, I came by train!

Q: What do you get when you plant cabbage and razor blades together?  
 A: Cole slaw!

Q: How can you tell when a Polak is about ready to pass your car?  
 A: When he fades back and cocks his arm.

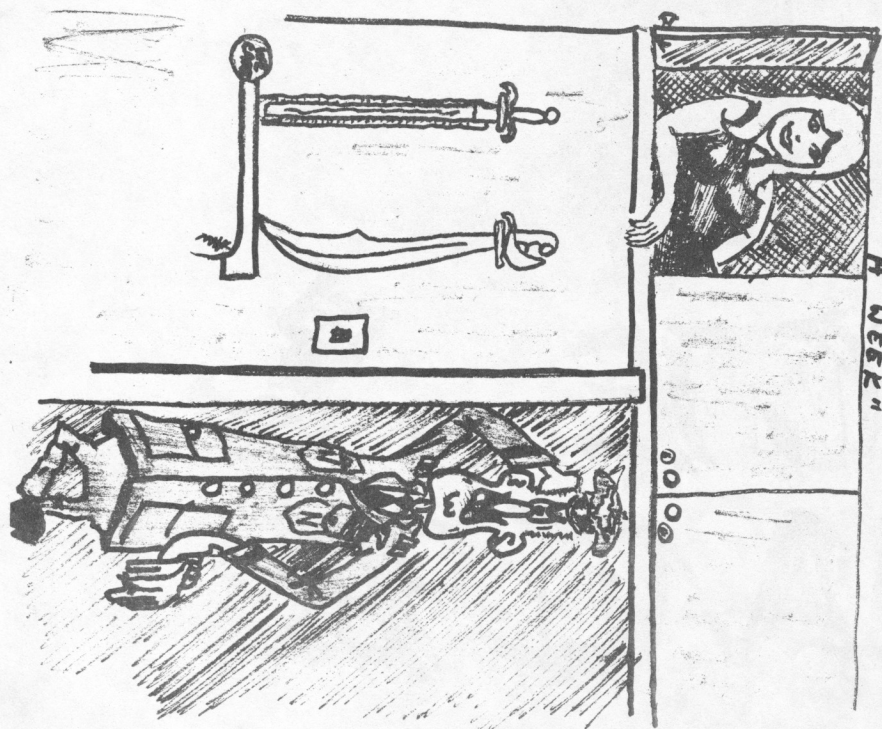

"I TRUST THAT YOU USE EVERYTHING IN YOUR OVERHEAD AT LEAST ONCE A WEEK"



"Cadets will not wear civilian clothes when moving to the new dorm"

-Sec.Flt.  
 4 Jan 68

This month's SPACE\*MATE is lovely Miss Patti "Jo" Sievers from Portland, Oregon. She is presently a freshman at Portland Community College and is studying to be a secretary. Among her favorite activities are water-skiing and swimming. Patti also presents a pretty sight at the beach filling out a 2-piece with a 36-25-36.



*The* **SPACE** *Mate*  
**MATE**





# Dorm, one each - new

Ladies and gentlemen, we are now entering the newest addition to USAFA - THE NEW DORM. This building was originally designed by David Vincent with a little extra-terrestrial help as evidenced by the psychedelic color patterns. As we start our tour, on the second floor you can see some of the vast improvements over Vandenburg Hall. Here in the first half of 20th Squadron, the rest of which is on the fifth floor, we will visit a typical cadet room. Please watch your heads as you enter the room. The first thing you will probably notice is the new ultra-modern, high valet unit. 'Ma'am, would you please turn on the right light - no, the right light - the switch for the right is on the left - that's right - no, left - never mind!' On a pleasant Saturday evening you can see many cadets cheerfully applying lemon oil to preserve the natural wood beauty of their rooms.



As we continue our tour of the second floor you will notice the ultra-modern tailor shoppe which has not yet been opened nor approved due to strong opposition from the Bain's lobby. Directly ahead, you can see the new safety feature; the fire doors, which if you will notice, open in only one direction. Due to a written petition by a number of cadets, a larger, new, improved barber shop has been installed in place of a cadet store.

In keeping with the mission of the Academy and physical fitness, Speas Hall serves a very good purpose. Walking is a great physical conditioner and THE NEW DORM is approximately 3 miles from the cadet gymnasium and parking lot. This of course shortens privileges by approximately 1/2 hour but "Ours is not to question why.."

Ladies and gentlemen, this concludes our tour of the new dorm.

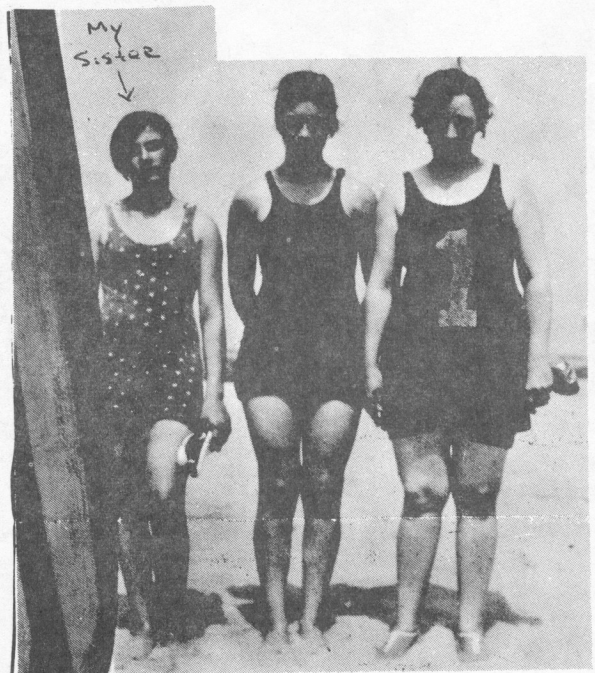

surf's up! retch!!

## Standard Equipment

in the new dorm

